

Valentine V2200T

The tank is seamlessly deep-drawn and made of chrome nickel steel. A tank volume of 2x 7-9 litres is available. There is many equipment options to choose from, including electronic control, oil pump and filtration system to simplify oil management or automatic basket lifting mechanism. The heaters can be pivoted out for cleaning purposes.

- Sophisticated technology
- User-friendly control
- Precise, even temperature management
- Consistent baking results
- Molten fat stage for gentle melting
- Easy to clean

Technical data:

Dimensions:	External dimensions: 400 x 580 mm
Output:	22.0 kW
Connector:	3x400 VAC
Control:	4 button operation
Anschluß:	3x400 VAC
Capacity:	2x 7-9 litres
Adjustment:	2 controllable frying tanks
Accessories:	CNS oil drawer with detachable coarse filter

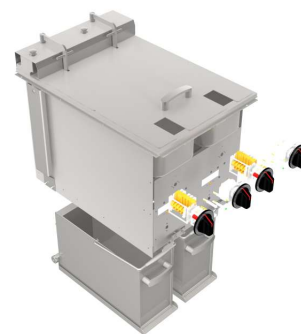

[Product weblink](#)

MENU SYSTEM AG
Oberstrasse 222
CH-9014 St. Gallen
Switzerland

T: +41 71 272 51 00
info@menusystem.ch
www.menusystem.ch

MENU SYSTEM Germany GmbH
Turmstrasse 4
D-78467 Konstanz
Germany

T: +49 1805 880558-10
info@menusystem.de
www.menusystem.de

MENU SYSTEM Austria GmbH
Steinebach 18
AT-6850 Dornbirn
Austria

T: +43 55 72 39 48 00
info@menusystem.at
www.menusystem.at